

Write your name here

Surname

Other names

**Pearson**  
**Edexcel GCSE**

Centre Number

--	--	--	--	--

Candidate Number

--	--	--	--	--

# Mathematics B

**Unit 2: Number, Algebra, Geometry 1**  
**(Non-Calculator)**

**Higher Tier**

Friday 8 November 2013 – Morning

**Time: 1 hour 15 minutes**

Paper Reference

**5MB2H/01**

**You must have:** Ruler graduated in centimetres and millimetres, protractor, pair of compasses, pen, HB pencil, eraser. Tracing paper may be used.

Total Marks



## Instructions

- Use **black** ink or ball-point pen.
- **Fill in the boxes** at the top of this page with your name, centre number and candidate number.
- Answer **all** questions.
- Answer the questions in the spaces provided – *there may be more space than you need.*
- **Calculators must not be used.**

## Information

- The total mark for this paper is 60
- The marks for **each** question are shown in brackets – *use this as a guide as to how much time to spend on each question.*
- Questions labelled with an **asterisk** (\*) are ones where the quality of your written communication will be assessed.

## Advice

- Read each question carefully before you start to answer it.
- Keep an eye on the time.
- Try to answer every question.
- Check your answers if you have time at the end.

Turn over ►

P44019A

©2013 Pearson Education Ltd.

6/5/4/2/1



**PEARSON**

# GCSE Mathematics 2MB01

Formulae: Higher Tier

**You must not write on this formulae page.  
Anything you write on this formulae page will gain NO credit.**

**Volume of prism** = area of cross section  $\times$  length

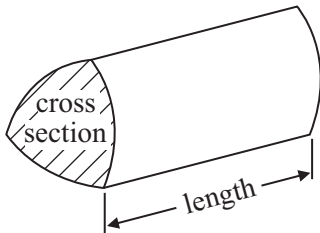

**Area of trapezium** =  $\frac{1}{2} (a + b)h$

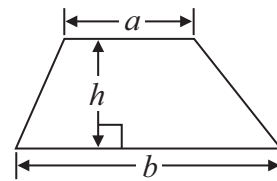

**Volume of sphere** =  $\frac{4}{3} \pi r^3$

**Surface area of sphere** =  $4\pi r^2$

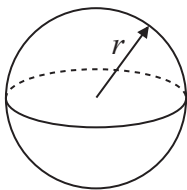

**Volume of cone** =  $\frac{1}{3} \pi r^2 h$

**Curved surface area of cone** =  $\pi r l$

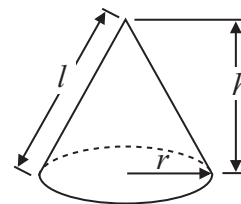

**In any triangle ABC**

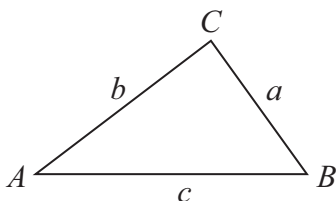

**The Quadratic Equation**

The solutions of  $ax^2 + bx + c = 0$   
where  $a \neq 0$ , are given by

$$x = \frac{-b \pm \sqrt{b^2 - 4ac}}{2a}$$

**Sine Rule**  $\frac{a}{\sin A} = \frac{b}{\sin B} = \frac{c}{\sin C}$

**Cosine Rule**  $a^2 = b^2 + c^2 - 2bc \cos A$

**Area of triangle** =  $\frac{1}{2} ab \sin C$



Answer ALL questions.

Write your answers in the spaces provided.

You must write down all stages in your working.

You must NOT use a calculator.

1 Here are some patterns made from white centimetre squares and grey centimetre squares.

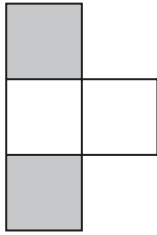

Pattern 1

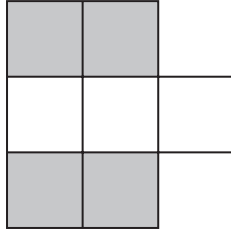

Pattern 2

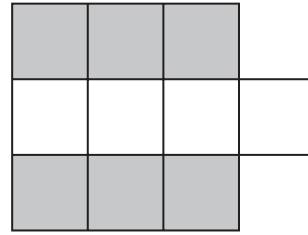

Pattern 3

A Pattern has 20 grey squares.

(a) Work out how many white squares there are in this Pattern.

.....  
(2)

(b) Find an expression, in terms of  $n$ , for the total number of centimetre squares in Pattern  $n$ .

.....  
(2)

(Total for Question 1 is 4 marks)

2 (a) Simplify  $5^4 \times 5^6$

.....  
(1)

(b) Simplify  $7^5 \div 7^2$

.....  
(1)

(Total for Question 2 is 2 marks)



3  $t = x^2 - 5y$   
 $x = 6$   
 $y = 4$

Work out the value of  $t$ .

.....  
**(Total for Question 3 is 2 marks)**

4 Diagram **NOT**  
accurately drawn

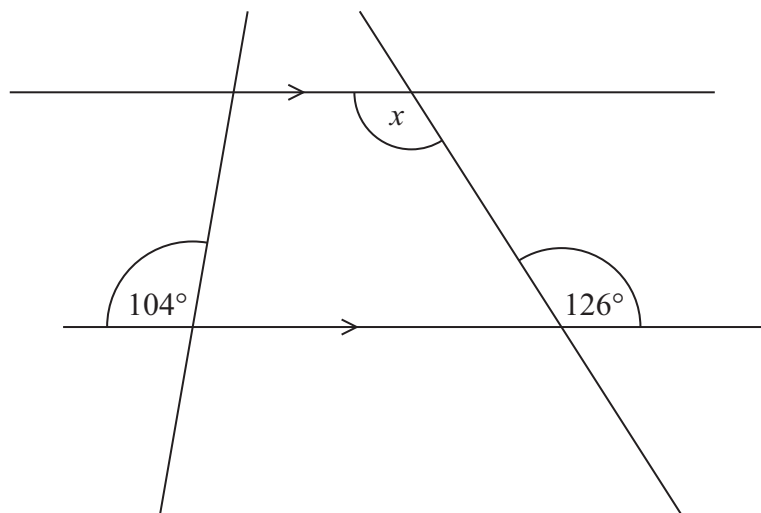

(i) Find the size of the angle marked  $x$ .

.....  
(ii) Give a reason for your answer.

.....  
**(Total for Question 4 is 2 marks)**



5 Here is a list of ingredients for making cherry scones.

**Makes 8 cherry scones**

200 grams flour

60 grams margarine

40 grams sugar

60 grams cherries

160 ml milk

Chen wants to make 20 cherry scones.

(a) Work out how much milk he will need.

.....ml  
(2)

Sophie has 80 grams of sugar and 300 grams of flour.  
She has plenty of the other ingredients.

\*(b) What is the greatest number of cherry scones she can make?  
You must show all your working.

(3)

**(Total for Question 5 is 5 marks)**



6 Here is a box in the shape of a cuboid.

Diagram **NOT**  
accurately drawn

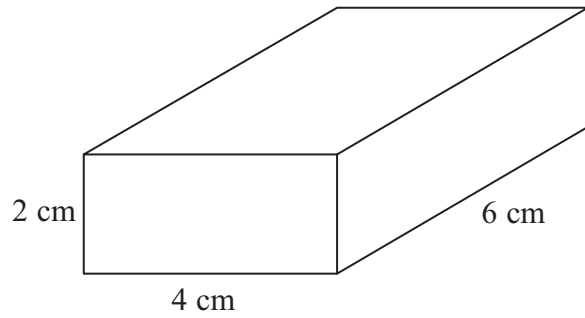

- (a) Complete an accurate drawing of the cuboid on the isometric grid.  
One edge of the cuboid has been drawn for you.

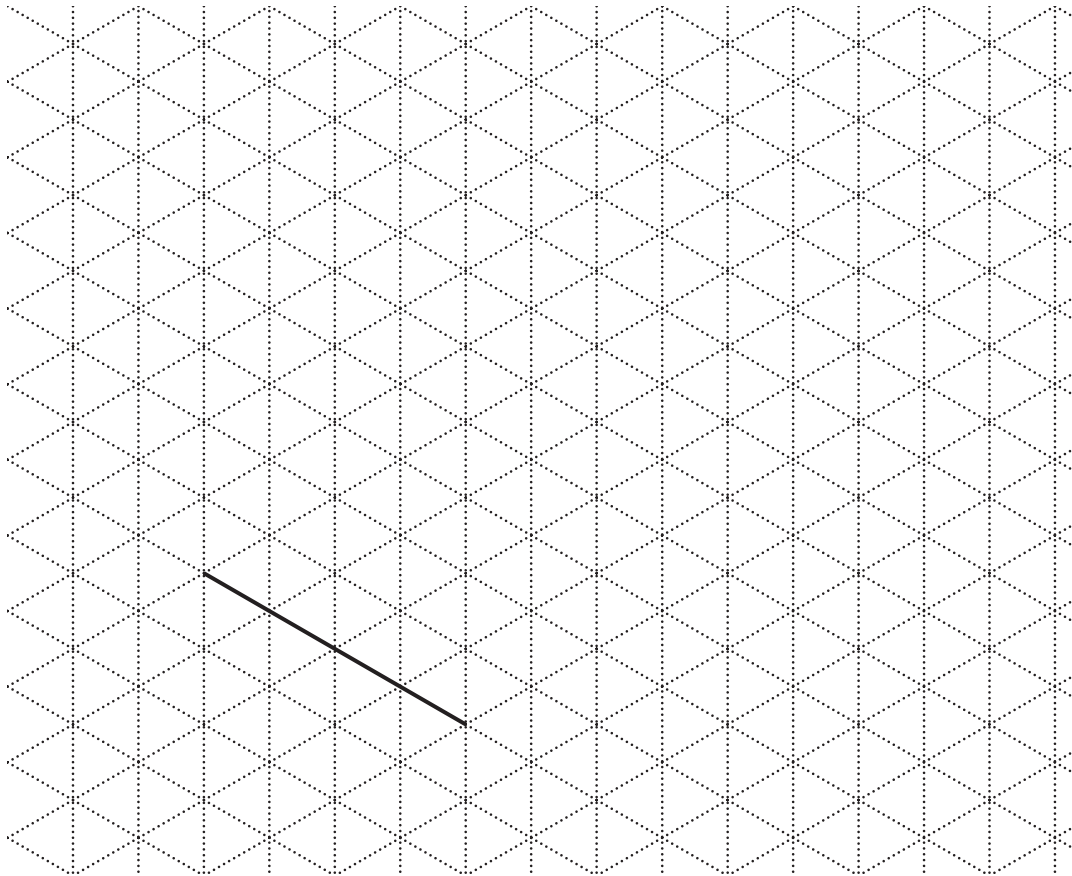

(2)



The box is made to hold cubes.  
Each cube has edges of length 2 cm.

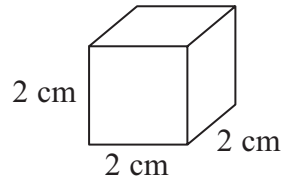

Diagram **NOT**  
accurately drawn

(b) Work out the largest number of cubes that can fit into the box.

.....  
(2)

**(Total for Question 6 is 4 marks)**



7 (a) Simplify  $2e + 3f - e + 4f$

.....  
(2)

(b) Expand  $5(2c + 3d)$

.....  
(1)

(c) Here are two straight lines,  $ABCDE$  and  $PQ$ .

Diagrams **NOT**  
accurately drawn

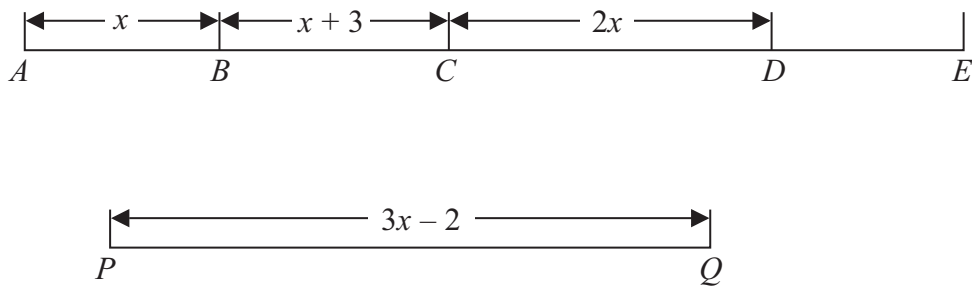

In the diagrams all the lengths are in cm.

$$AE = 2PQ.$$

Find an expression, in terms of  $x$ , for the length of  $DE$ .

Give your answer in its simplest form.

.....cm  
(4)

(Total for Question 7 is 7 marks)





8 Work out an estimate for the value of  $\frac{89.3 \times 0.51}{4.8}$

.....  
(Total for Question 8 is 2 marks)

9 (a) Write 152 million in standard form.

.....  
(2)

(b) Write  $2.4 \times 10^{-3}$  as an ordinary number.

.....  
(1)

(Total for Question 9 is 3 marks)



10

Diagram **NOT**  
accurately drawn

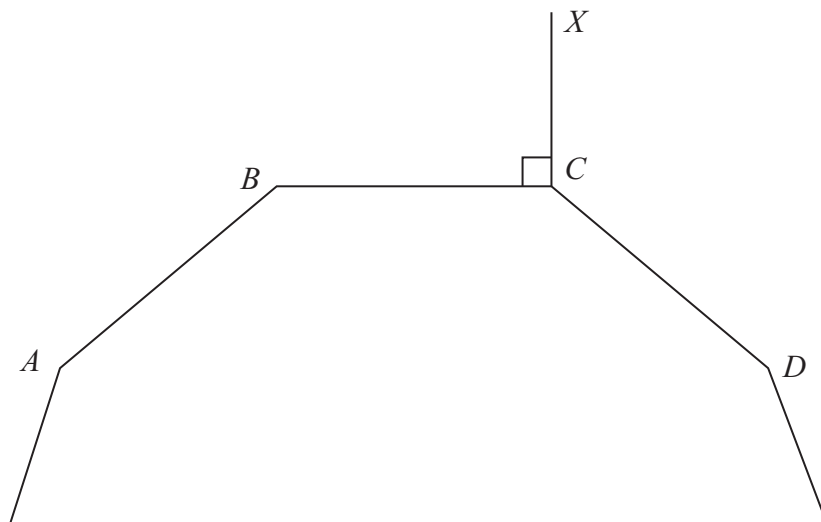

$A$ ,  $B$ ,  $C$  and  $D$  are four vertices of a regular 10-sided polygon.  
Angle  $BCX = 90^\circ$ .

Work out the size of angle  $DCX$ .

.....  
(Total for Question 10 is 3 marks)



11 Here is the cross section of a steel girder.  
The cross section has two lines of symmetry.

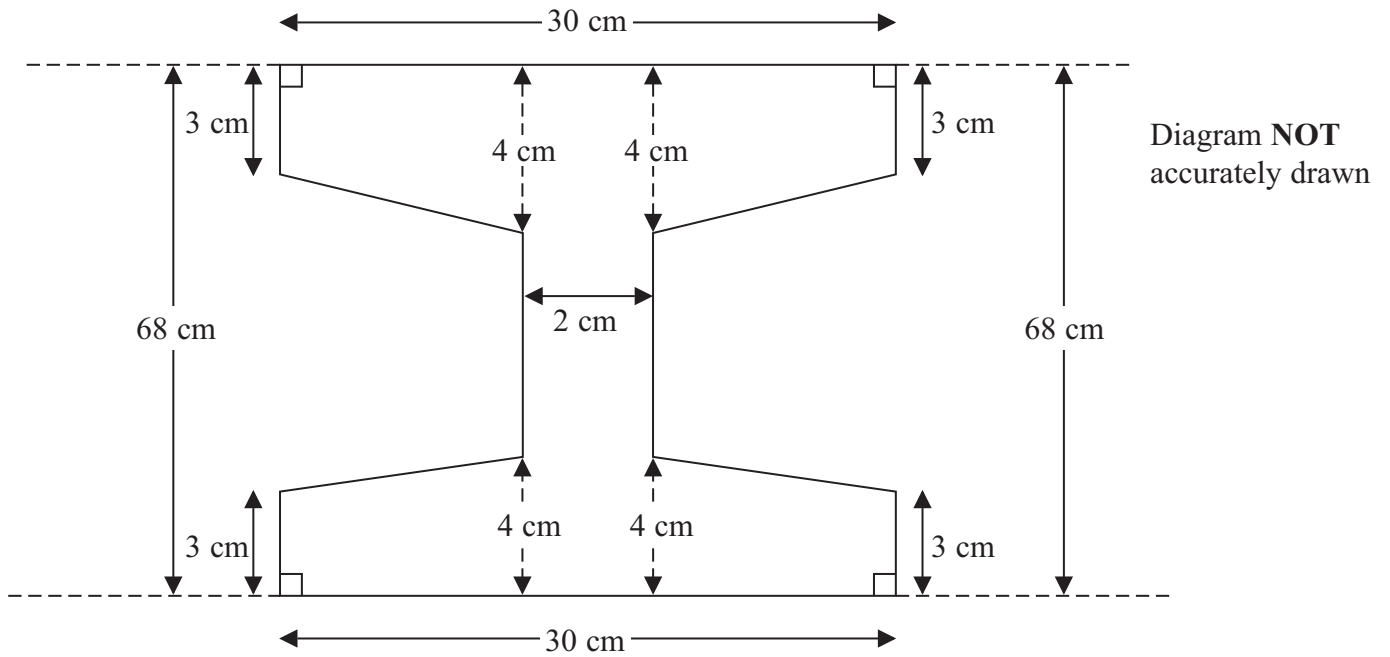

The girder is a prism.  
The length of the girder is 200 cm.  
Work out the volume of the girder.

.....cm<sup>3</sup>

(Total for Question 11 is 5 marks)



12 (a) Factorise fully  $6ab + 10ac$

.....  
(2)

(b) Expand and simplify  $(x - 5)(x + 7)$

.....  
(2)

(c) Simplify  $\frac{2m^2t^6}{m^4t^2}$

Give your answer in its simplest form.

.....  
(2)

(d) Factorise  $y^2 - 16$

.....  
(1)

(e) Simplify  $(h^2)^{-3}$

.....  
(1)

(Total for Question 12 is 8 marks)



- 13 The perimeter of a square is  $\sqrt{120}$  cm.  
Work out the area of the square.  
Give your answer in its simplest form.

.....cm<sup>2</sup>

**(Total for Question 13 is 3 marks)**

---



\*14

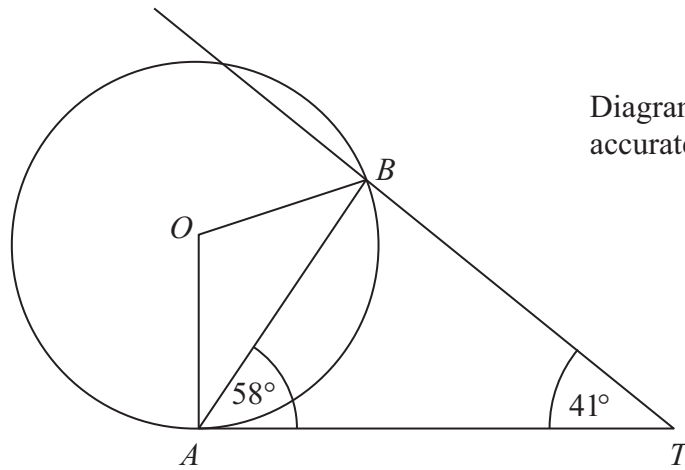

Diagram **NOT**  
accurately drawn

$A$  and  $B$  are points on the circumference of a circle, centre  $O$ .

$AT$  is a tangent to the circle.

Angle  $TAB = 58^\circ$ .

Angle  $BTA = 41^\circ$ .

Calculate the size of angle  $OBT$ .

You must give reasons at each stage of your working.

(Total for Question 14 is 5 marks)



**15**  $L$  is a straight line.

The gradient of  $L$  is 4

$L$  passes through the point  $(0, 2)$ .

(a) Write down an equation of the straight line  $L$ .

.....  
(2)

$L_1$  is a straight line parallel to  $L$ .

$L_1$  passes through the point with coordinates  $(2, -6)$

(b) Find an equation of  $L_1$ .

.....  
(3)

---

**(Total for Question 15 is 5 marks)**

---

**TOTAL FOR PAPER IS 60 MARKS**



**BLANK PAGE**

